

DSP voice and audio technologies for products based on CSR ICs





Company info

Founded 2002

Offices:

- Headquarters: Haifa (Israel)
- R&D: Haifa (Israel), St. Petersburg (Russia)
- Regional sales representative: China, Korea, Singapore, Taiwan, Japan

Main business:

- DSP software technologies for voice, audio and hearing enhancement

Main business model:

- Technologies licensing, NRE (porting, customization, support)

Status:

- Profitable, growing, expanding to new markets

Competitive advantage:

- Richest portfolio of technologies for a variety of applications
- Advanced tuning, unique signal logging and auxiliary tools
- Fast and efficient customer support



Areas of operation:

- Enabling natural voice communication and music experience in any environment
- Automotive, mobile, mobile accessories, conferencing, hearing enhancement, law enforcement
- Over 20 million products



Alango solutions



Voice communication

Voice Communication Package of integrated basic and advanced front-end software DSP technologies (beamforming, echo/noise cancellation, equalizers, automatic gain control and others)



Voice reinforcement (demo available, release 2016/Q3)

Car Intercom Package of software DSP technologies for in-cabin voice communication (acoustic feedback cancellation, noise reduction, automatic gain control and others)



Speech recognition enhancement

Dual and single microphone speech enhancement with stereo echo cancellation



Music enhancement

Stereo expansion, spectral enhancement, bass emphasis, dynamic range compression, frequency equalization



Hearing enhancement

Complete software reference design for integrating personal sound amplification, assistive listening and Bluetooth headset functionality



Alango-CSR customers

Products of these companies incorporate Alango technologies running on Kalimba DSP





Voice Communication

Voice Communication Package (VCP)

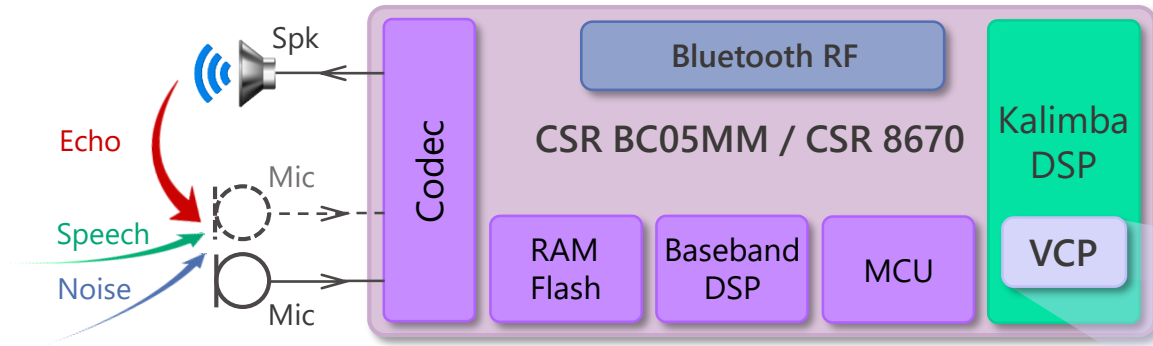

All front-end voice processing technologies in one package

Available for:
BC05MM, CSR 8670, CSR 8675

Supports:
Narrowband (8KHz), Wideband (16KHz),
Super-wideband (24KHz) speech

Simple integration:
VCP interface is **fully compatible** with CSR CVC plug-in

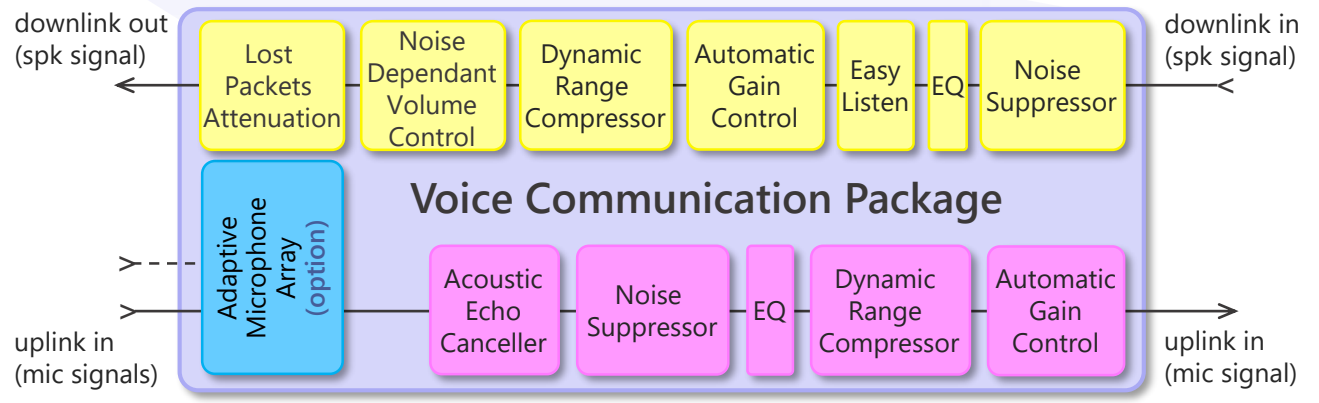

Voice Communication

Voice Communication Package Technologies

- 🔊 **ADM - Adaptive Directional Microphone:**
Utilizes information from additional microphones to attenuate all types of noises including babble and wind noise
- 🔊 **AEC - Acoustic Echo Canceller:**
Eliminates acoustic echoes with multi-band residual echo suppressor ensuring full-duplex communication
- 🔊 **NS - Noise Suppressor:**
Detects and attenuates stationary and transient noises (traffic, engine, passing cars, etc.) in transmitted and received signals
- 🔊 **DRC - Dynamic Range Compressor:**
Improves speech intelligibility, reduces speaker distortions
- 🔊 **AGC - Automatic Gain Control:**
Compensates possible changes in voice signal levels

- 🔊 **NDVC – Noise Dependent Volume Control:**
Automatically increases the loudspeaker volume according to the current ambient noise level
- 🔊 **EasyListen™:**
Dynamically slows down incoming speech improving intelligibility of fast talkers or foreign language
- 🔊 **LPA – Lost Packet Attenuation:**
Improves perceptual speech quality of Bluetooth packet loss
- 🔊 **RTSL – Real Time Signal Logging:**
Unique feature allowing real time VCP input/output signal monitoring, logging and listening



Voice Communication

Real Time Signal Logging

Alango has developed an unique signal logging and monitoring tools greatly facilitating system tuning and problem report procedures:

- Recording all VCP inputs and outputs on PC
- Real time level monitoring of input/output levels
- Real time listening of any input/output channel
- Rx-Tx delay detection (correlator)
- Real time waveform/spectrogram of input/output signals
- Simple, 2 wires (PIO+GND) connection between the Alango Logger device and device under test
- USB connection to PC

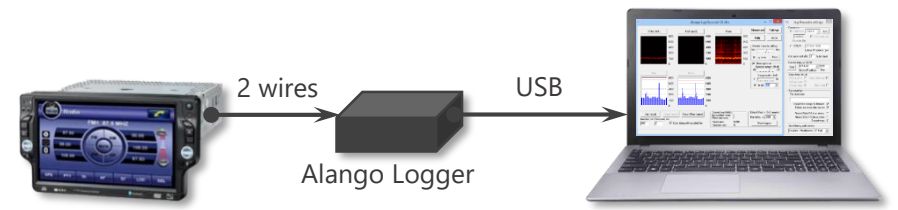
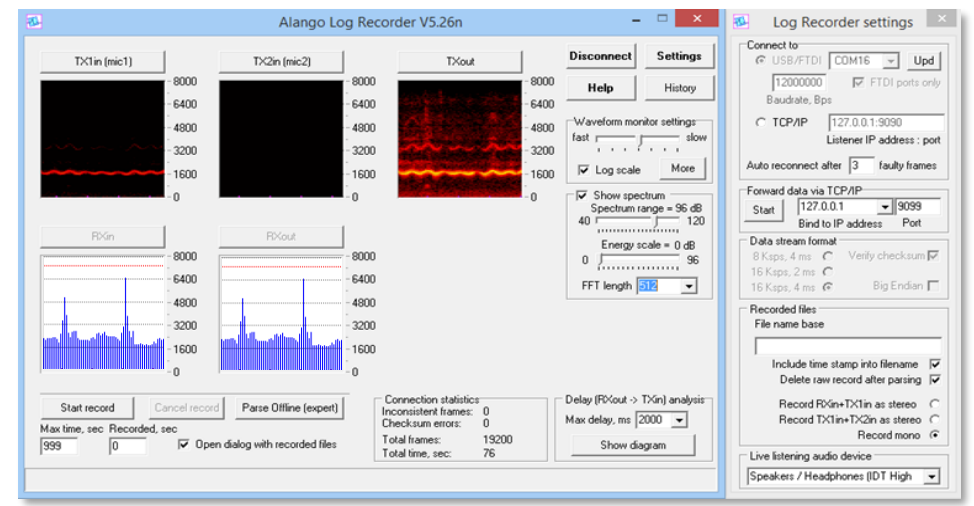



Voice Communication

Alango configuration auxiliary tools

Alango software packages come with convenient, graphical parameter configuration tools allowing real-time, intuitive hands-free system tuning and performance validation.

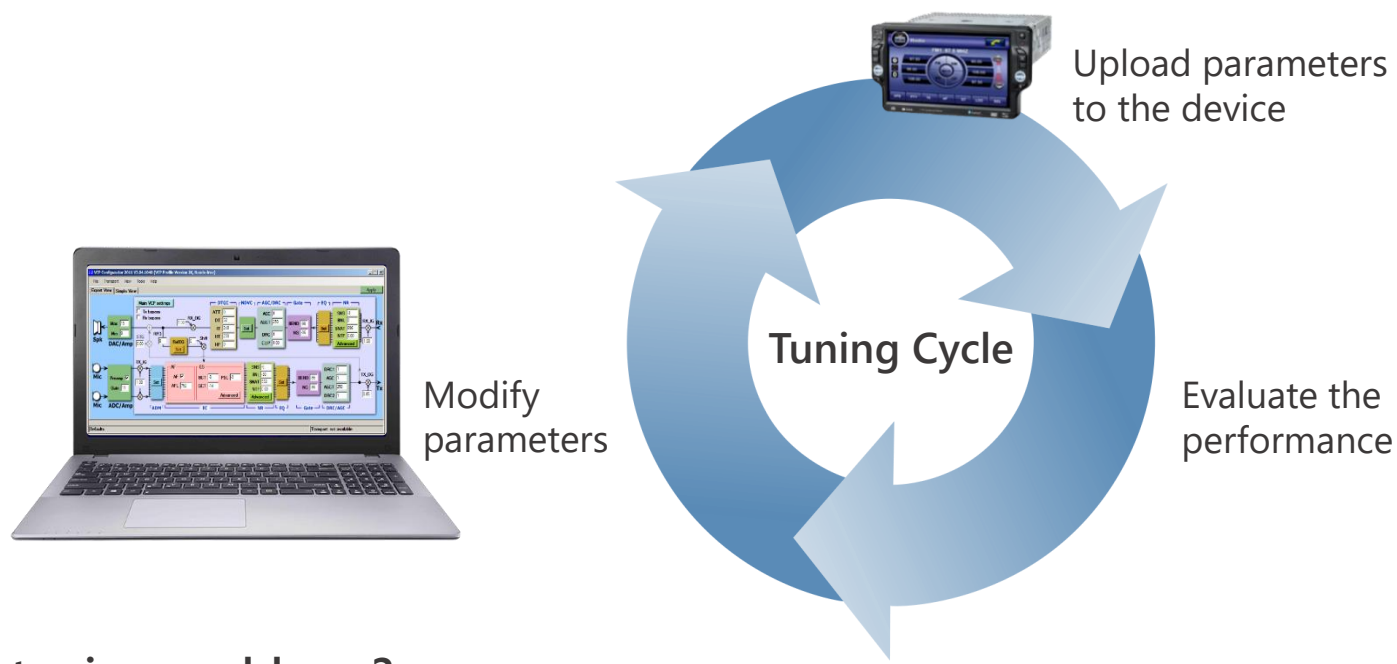

Having tuning problems?
Record log signal files and send to us for analysis.



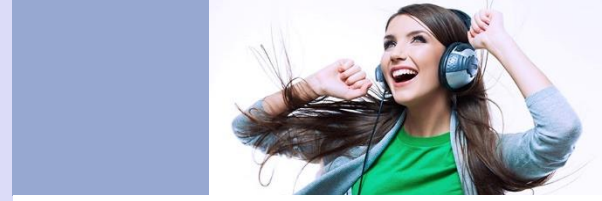

Music enhancement

MuRefiner – audio enhancement

Music Refiner (MuRefiner™) – an unique set of audio enhancement technologies for mobile applications

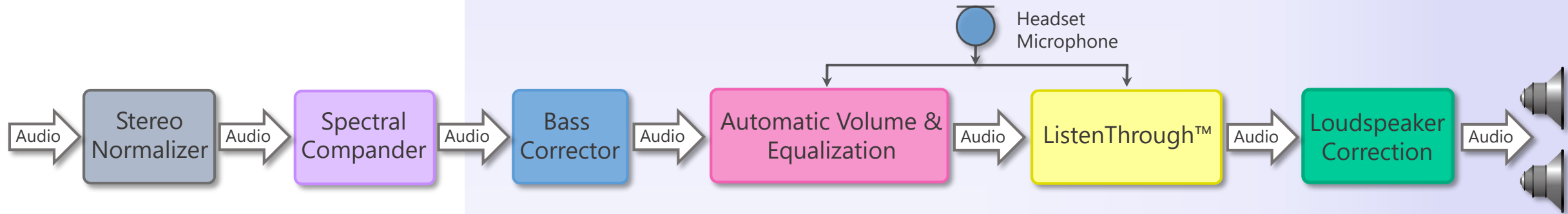

Stereo Normalizer

Expands, shrinks or normalizes stereo effect making it optimal for the device and individual user preferences

Spectral Componder

Dynamically reduces the spectral variance making music more enjoyable in mobile conditions

Bass Corrector

Boosting up bass line while preventing the speaker and power amplifier from overload

Automatic volume and frequency equalization (headphones)

Automatically adjusting volume and frequency equalizer according to the ambient noise

ListenThrough™

Important environmental sounds (loud voices, car horns, etc.) are amplified to increase user awareness and safety while listening music at high volume

Loudspeaker response correction (roadmap for 2015-2016)

Correction of loudspeaker amplitude and phase response for reproducing natural sound

MuRefiner is integrated into Apt-X, SBC, MP3 decoders running on Kalimba DSP



Music enhancement

Automatic Volume and eQualization control

Automatic Volume and eQualization (AVQ) control technology provides an efficient, “hands-free” alternative to manual volume and frequency equalizer adjustment dependent on ambient noise changes.

The communication microphone is used to monitor the ambient noise properties.

The audio and the microphone signals are each divided into several frequency bands.

The audio frequency bands are amplified according to the noise level in the corresponding microphone frequency bands ensuring a comfortable signal to noise ratio over the whole frequency range.

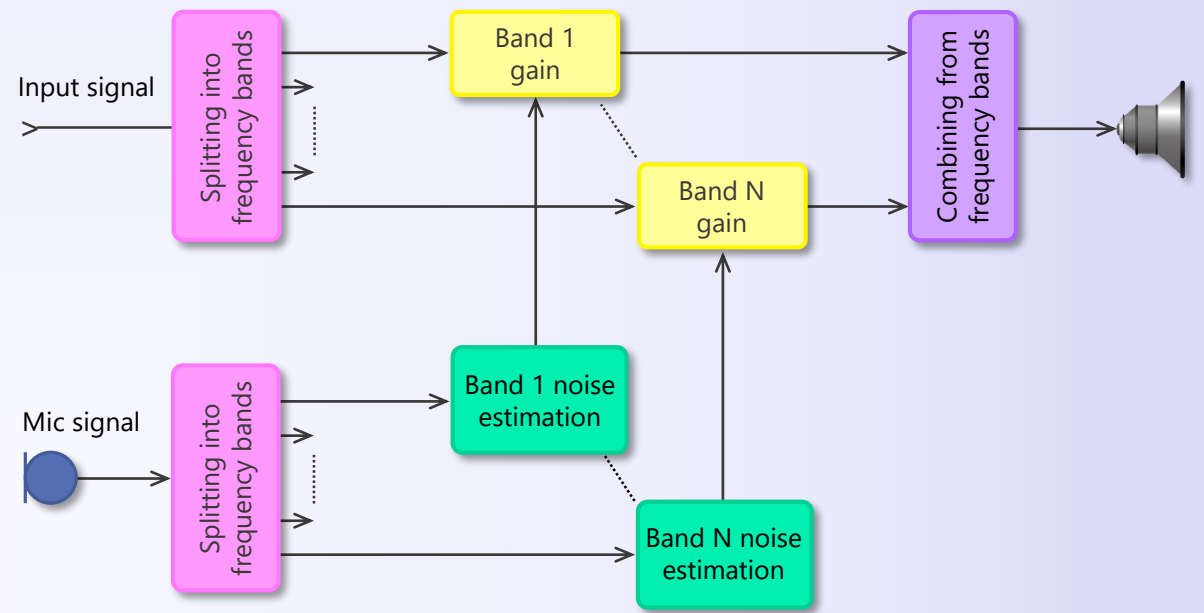



Voice reinforcement

Scheduled for release in 2015/Q4 **In-Car Voice Communication (IVC)** – a set of technologies for enabling easy in-vehicle voice communication between front and rear seats without turning the head or raising driver’s voice.

Creating **in-vehicle intercom system** is complicated by acoustic feedback problems caused by:

- Strong acoustic coupling between loudspeaker and microphones
- High noise levels while driving requiring large speaker volume
- Large distance from the driver to the microphone requiring large microphone gain

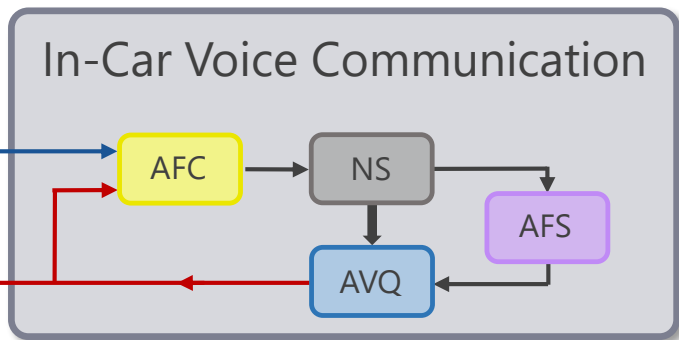
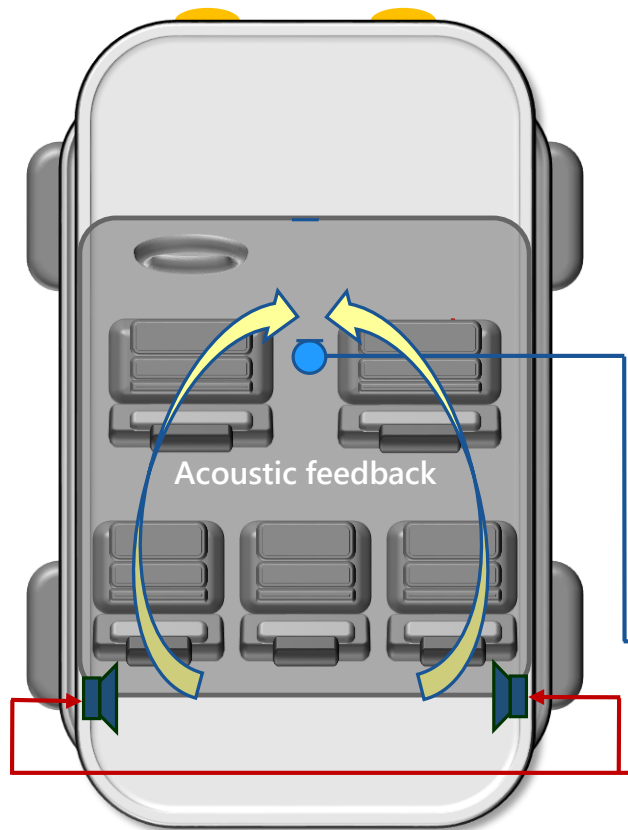

AFC – Acoustic Feedback Cancellation
 NS – Noise Suppression
 AVQ – Automatic Volume & eQualization
 AFR – Acoustic Feedback Suppression



Speech recognition enhancement

Voice Communication Package technologies can significantly enhance voice quality for voice communication and automatic speech recognition applications. Special **Voice Enhancement Package (VEP)** will be introduced in 2016.

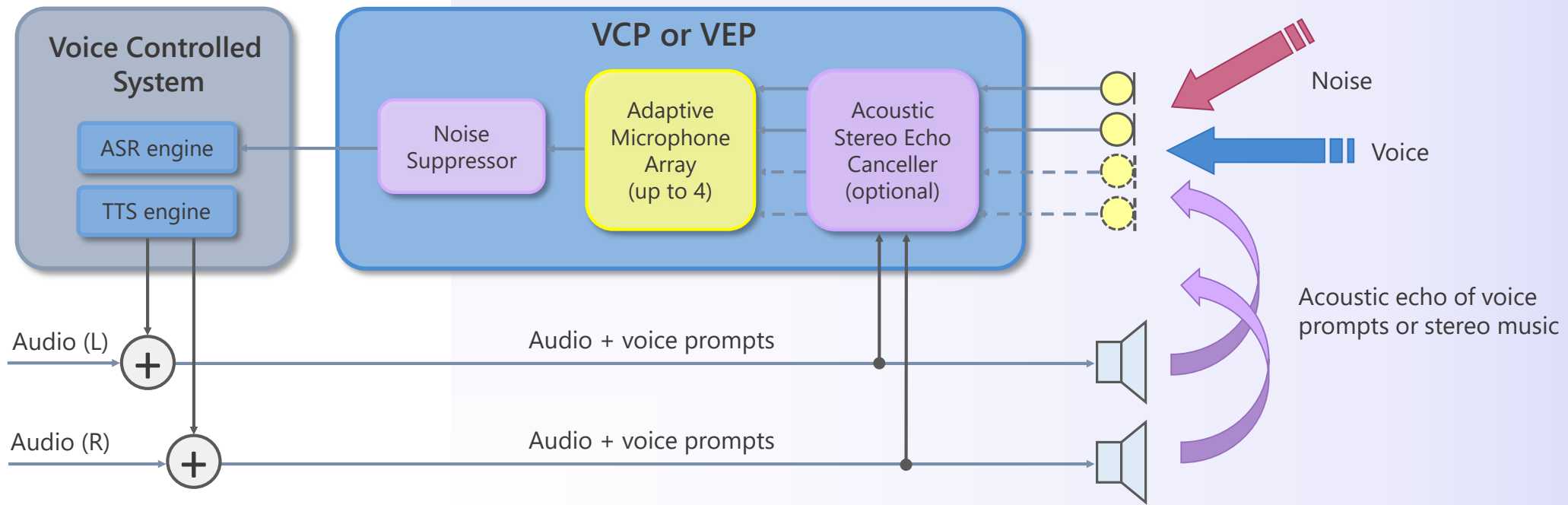



Speech recognition enhancement

Objective speech enhancement tests

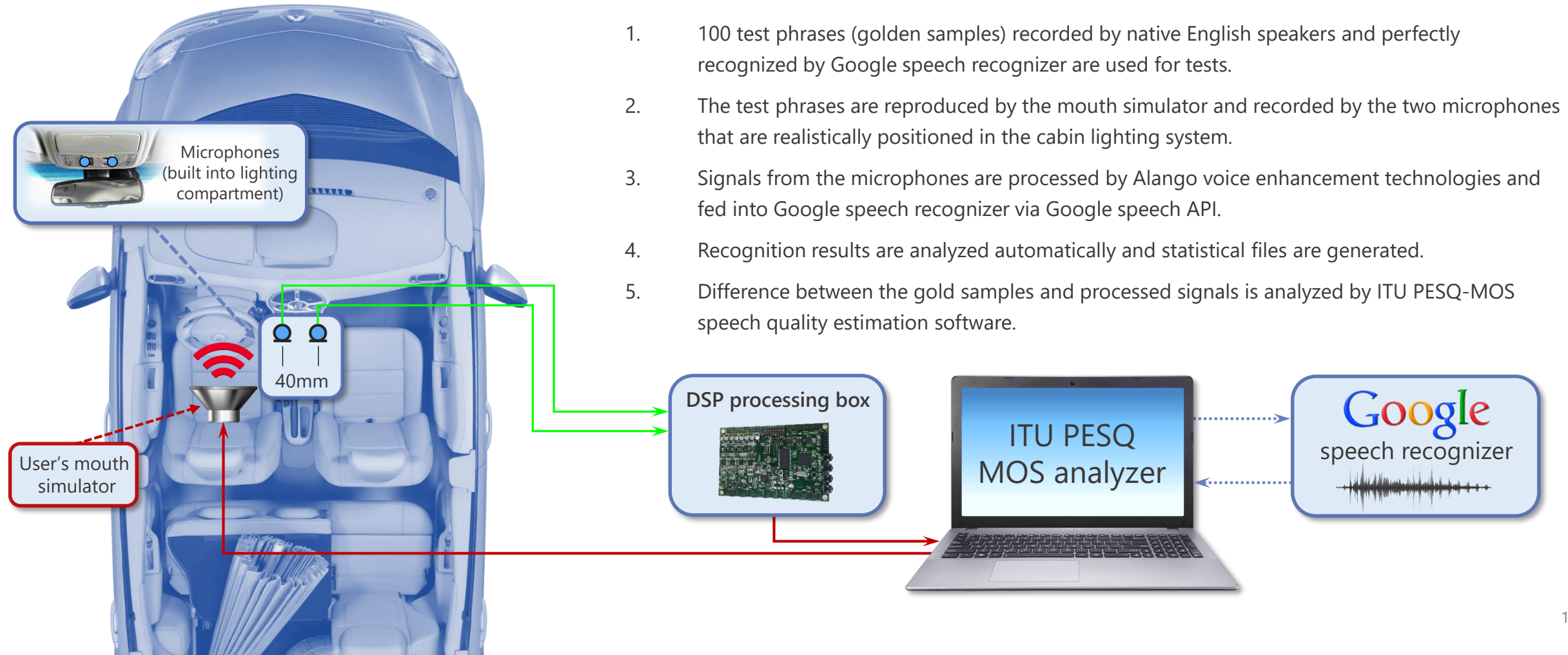

1. 100 test phrases (golden samples) recorded by native English speakers and perfectly recognized by Google speech recognizer are used for tests.
2. The test phrases are reproduced by the mouth simulator and recorded by the two microphones that are realistically positioned in the cabin lighting system.
3. Signals from the microphones are processed by Alango voice enhancement technologies and fed into Google speech recognizer via Google speech API.
4. Recognition results are analyzed automatically and statistical files are generated.
5. Difference between the gold samples and processed signals is analyzed by ITU PESQ-MOS speech quality estimation software.



Tests have been conducted in Ford Focus Estate 2012

Speech recognition enhancement

Speech recognition quality improvement with VCP

Percentage of phrases recognized precisely with and without VCP speech enhancement technologies

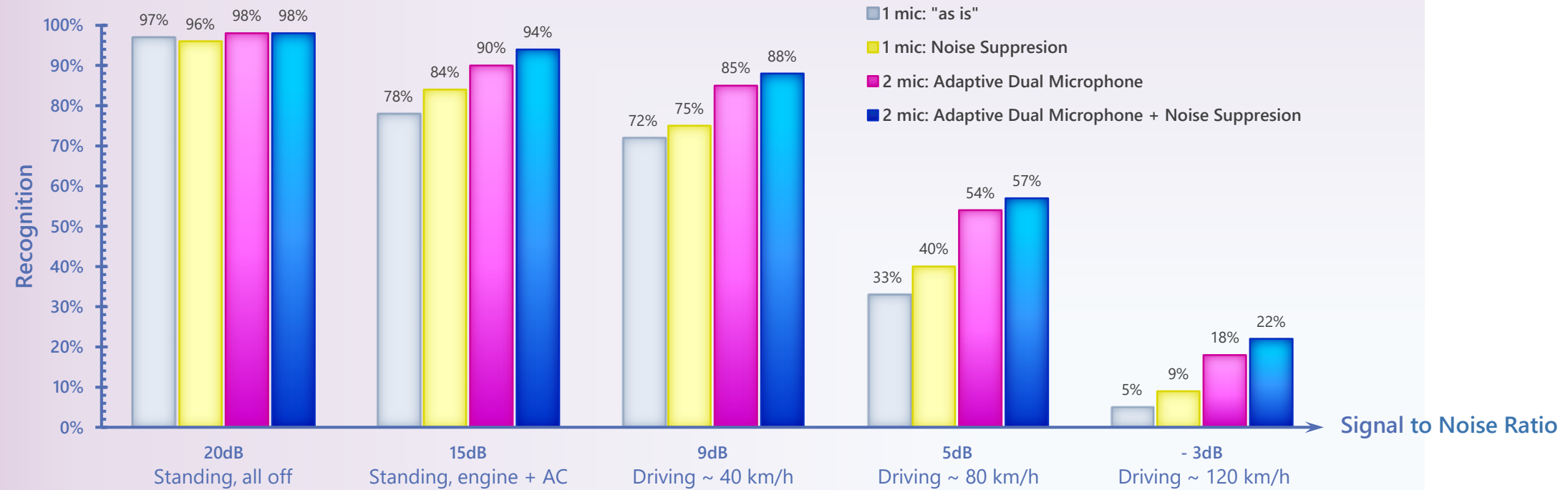



Tests have been conducted in Ford Focus Estate 2012

Speech recognition enhancement

Objective voice quality improvement with VCP

VCP speech quality enhancement according to ITU PESQ-MOS (Mean Opinion Score)

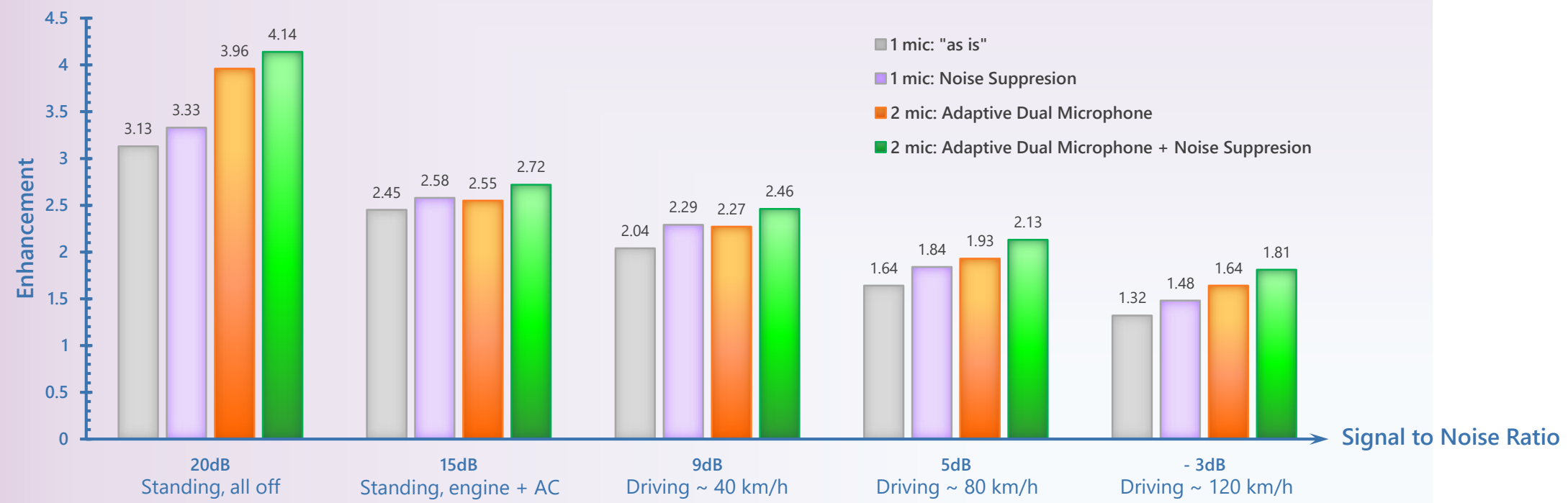

ITU PESQ-MOS estimates the quality of a signal by comparing it to the golden sample. The estimation is supposed to match that of a mean human listener. Higher numbers are better, but the best quality is limited to 4.5 (perfect match)



Hearing enhancement

Potential market of >500M people world wide that cannot be addressed by the traditional hearing aid industry

HearPhones:

Reference design for a revolutionary Bluetooth headset with hearing enhancement and assistive listening capabilities.

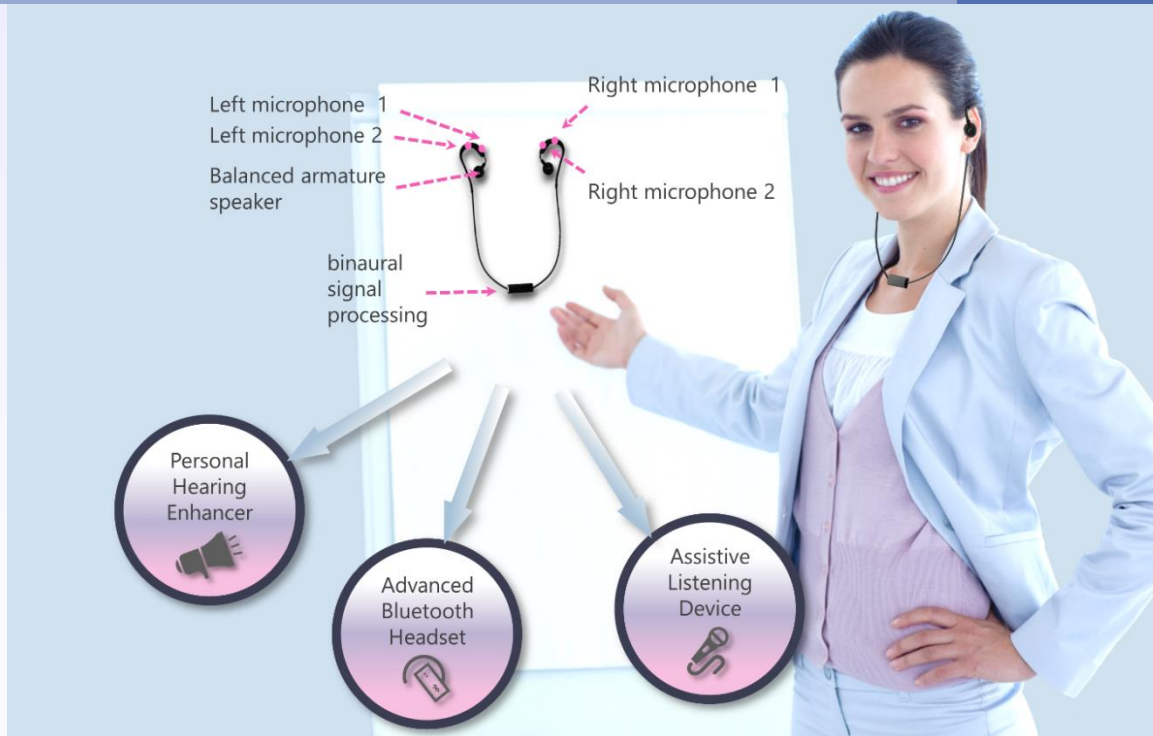



Hearing enhancement

HearPhones SDK content

- Best in class digital signal processing libraries for all modes: hearing enhancement, phone call, assistive listening
- Source code for CSR 8670 MCU implementing all HearPhones functionality
- Software configuration tools
- Product design guidelines
- Android and iOS example code for the control application





Hearing enhancement

HearPhones as Personal Hearing Enhancer

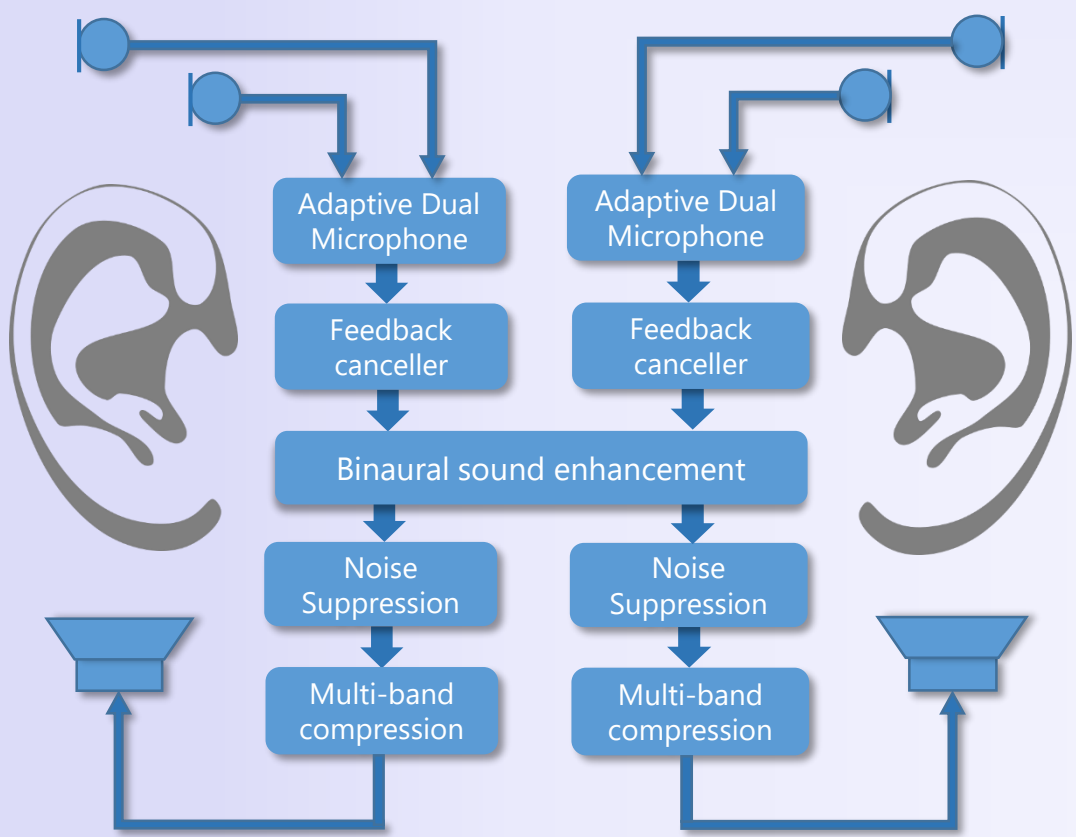

- HearPhones perform all digital signal processing tasks necessary to enhance human hearing with high frequency resolution.
- CSR 8670 Kalimba DSP is 3-5 times faster than processors used in most digital hearing aids.
- Binaural and monaural versions supporting various product styles (casual, fashion, business, sport, luxury)





Contact information

Don't hesitate to contact us if you want to be our customer or just have some comments. We are looking forward to hearing from you!

Please, send your questions, comments, thoughts, proposals to info-il@alango.com or specifically to:

- Mr. Robert Schragger (Sales enquiries): sales-il@alango.com
- Mr. Alex Radzishovsky (Technical enquiries): tech-il@alango.com
- Dr. Alexander Goldin (CEO): ceo-il@alango.com

Alango Technologies Ltd.
2 Etgar St. PO Box 62
Tirat Carmel 39100 Israel

Phone numbers:
Main office: +972 4 8580 743
Fax: +972 4 8580 621